

# Unicase

## Unicase Instrument Cases

Attractive, universal enclosures for desktop or portable electronics. Total access design for fast assembly and equipping. Internal assembly extrusions with four guide rail positions for mounting PCBs. Anodised aluminium front panels included.

## Unicase Instrumenten-Gehäuse

Attraktives, universelles Gehäusesystem für Tischgeräte oder mobile Anwendungen. Besonders gute Zugänglichkeit bei Montage- und Bestückungsarbeiten. Interne Montageprofile mit vier Führungspositionen für die Befestigung der Leiterkarten. Eloxierte Aluminium Frontplatten sind beigelegt.

## Boîtier Unicase pour instruments

Système de boîtiers universel et d'aspect plaisant pour appareils de table ou applications portables. Très bonne accessibilité pour les opérations de montage et la mise en place des composants. Profilés de montage internes avec quatre positions de guidage pour la fixation des circuits imprimés. Les plaques avant en aluminium anodisé sont comprises dans la livraison.

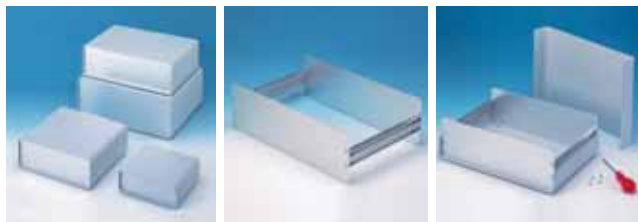

RAL 7035

Standard colour  
Standardfarbe  
Coloris standard

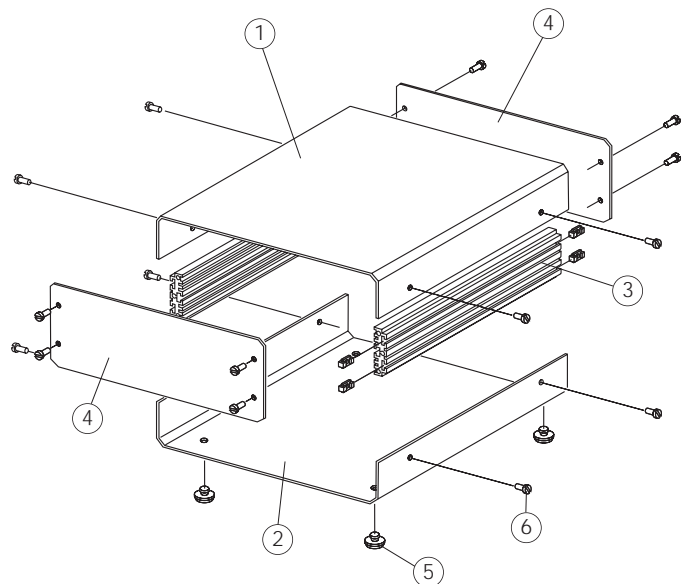

### Supply

- ① Top cover
- ② Base cover
- ③ Assembly profile (x2)
- ④ Front panel (x2)
- ⑤ Rubber Foot (x4)
- ⑥ M3 x 8 mm (x16)

### Lieferumfang

- Oberteil
- Unterteil
- Montageprofile (x2)
- Frontplatte (x2)
- Gummifuß (x4)
- M3 x 8 mm (x16)

### Fourniture

- Partie supérieure
- Partie inférieure
- Profilés de montage (x2)
- Plaque avant (x2)
- Pied de boîtier (x4)
- M3 x 8 mm (x16)

### Unibase 1

185mm 180mm 65mm  
7.283" 7.087" 2.559"

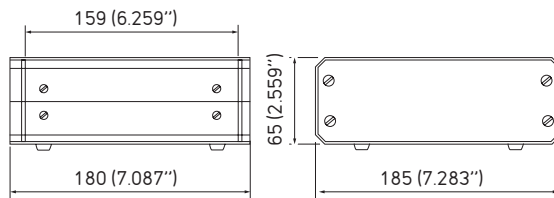

**Part No.**  
Bestell-Nr./Réf.  
**M 55 01 110**

### Unibase 1



### Unibase 2

260mm 250mm 90mm  
10.236" 9.842" 3.543"

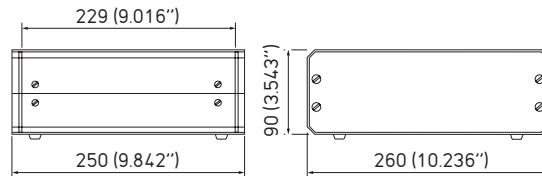

**Part No.**  
Bestell-Nr./Réf.  
**M 55 02 110**

### Unibase 2



### Unibase 3

350mm 250mm 110mm  
13.779" 9.842" 4.331"

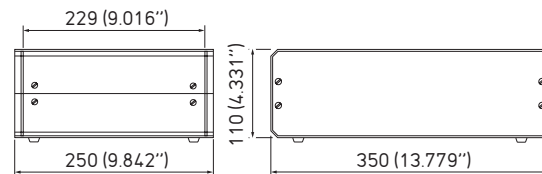

**Part No.**  
Bestell-Nr./Réf.  
**M 55 03 110**

### Unibase 3



### Unibase 4

261mm 300mm 134.5mm  
10.275" 11.811" 5.295"

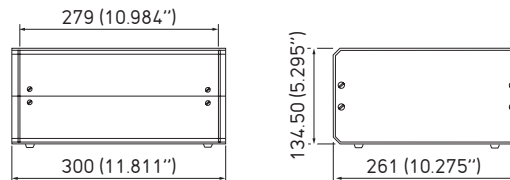

**Part No.**  
Bestell-Nr./Réf.  
**M 55 04 110**

### Unibase 4



### Unibase 5

367mm 300mm 134.5mm  
14.449" 11.811" 5.295"

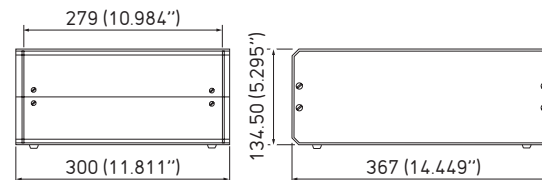

**Part No.**  
Bestell-Nr./Réf.  
**M 55 05 110**

### Unibase 5



### Unibase 6

474mm 300mm 134.5mm  
18.661" 11.811" 5.295"

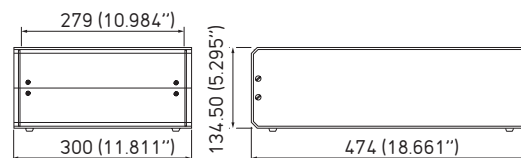

**Part No.**  
Bestell-Nr./Réf.  
**M 55 06 110**

### Unibase 6



Unibase SL1

NEW!

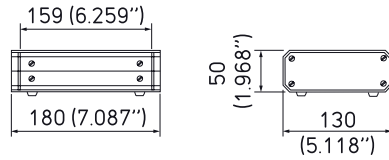

Unibase SL1

130mm	180mm	50mm
5.118"	7.087"	1.968"

**Part No.**  
Bestell-Nr./Réf.  
**M 55 11 110**

Unibase SL2

NEW!

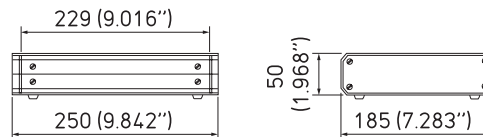

Unibase SL2

185mm	250mm	50mm
7.283"	9.842"	1.968"

**Part No.**  
Bestell-Nr./Réf.  
**M 55 12 110**

Unibase SL3

NEW!

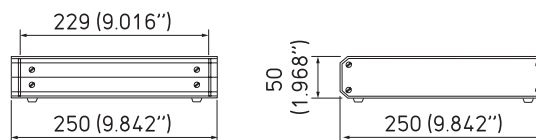

Unibase SL3

250mm	250mm	50mm
9.842"	9.842"	1.968"

**Part No.**  
Bestell-Nr./Réf.  
**M 55 13 110**

Unibase SL4

NEW!



Unibase SL4

250mm	300mm	50mm
9.842"	11.811"	1.968"

**Part No.**  
Bestell-Nr./Réf.  
**M 55 14 110**